

THESE ENGINEERING DRAWINGS HAVE BEEN PREPARED BY SOUTHERN HYDRAULIC CYLINDER, INC. ("SHC") BASED ON PARTICULAR INFORMATION AND DESIGN SPECIFICATIONS PROVIDED BY THE CUSTOMER. SHC ASSUMES NO RESPONSIBILITY FOR SUCH PARTICULAR INFORMATION OR DESIGN SPECIFICATIONS PROVIDED AND ASSUMES NO RESPONSIBILITY FOR ANY SPECIFIC APPLICATION OF THE PRODUCT RESULTING FROM THE DESIGN SPECIFICATIONS. CUSTOMER SHALL INDEMNIFY SHC AGAINST ANY CLAIM BY ANY PARTY FOR DAMAGES BASED ON ANY ERROR, OMISSION OR FAULT IN THE PARTICULAR INFORMATION OR DESIGN SPECIFICATIONS PROVIDED BY THE CUSTOMER.

THIS PRINT CONTAINS CONFIDENTIAL INFORMATION AND IS THE PROPERTY OF SOUTHERN HYDRAULIC CYLINDER, INC. AND IS NOT TO BE COPIED OR REPRODUCED WITHOUT THE EXPRESSED CONSENT OF SOUTHERN HYDRAULIC CYLINDER, INC.

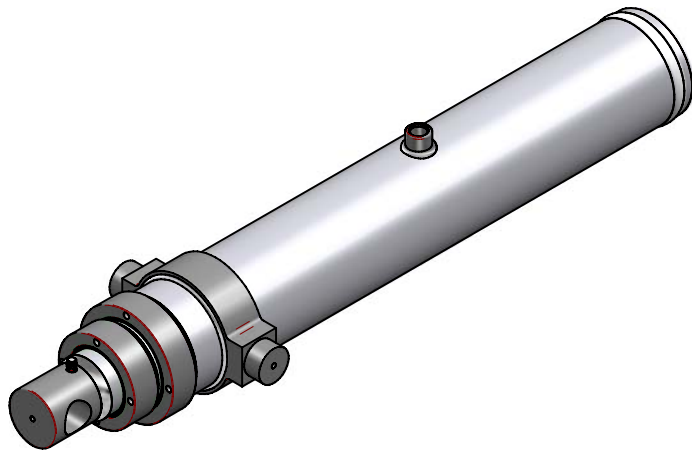
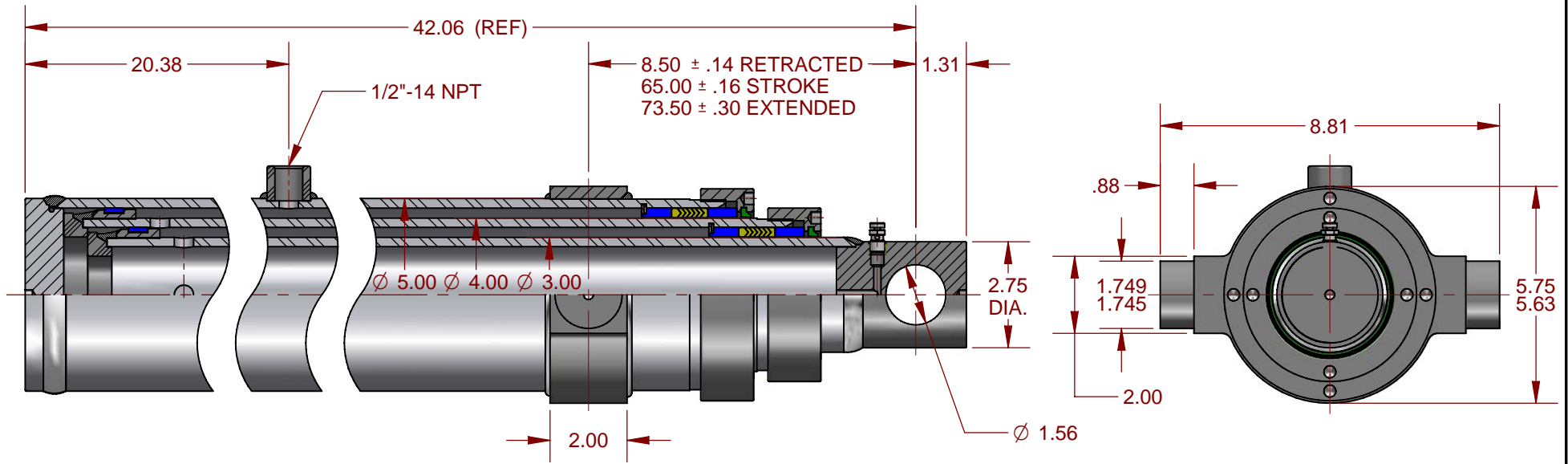

NOTES:

1. SEAL KIT NUMBER: 42SA.
2. MAX. OPERATING PRESSURE: 2500 PSI.
3. PAINT NUMBER: UN1263 RED OXIDE PRIMER.
4. OIL CAPACITY(GAL): 1.66 RETRACTED; 4.41 EXTENDED.
5. CYLINDER WEIGHT (LBS) APPROX. 115

3020 Lee Highway Athens, Tennessee 37303	
MACHINING TOLERANCES UNLESS OTHERWISE SPECIFIED ONE PLACE .X = ±.1 TWO PLACES .XX = ±.03 THREE PLACES .XXX = ±.010 FOUR PLACES .XXXX = ±.0010 ALL ANGLES = ±2° BREAK ALL SHARP EDGES .010 X 45°	DRAWN BY _____ CHECKED _____ APPROVED _____ SCALE _____
DO NOT SCALE DRAWING FOR MACHINING DIMENSIONS	
TELESCOPIC CYLINDER ASSEMBLY	
DRAWING NO. 4265TR	

CHANGE	NO	DATE	BY
CUSTOMER STD SHCI CYLINDER			
FILE SE			